

M12 female 90° shielded with cable

PVC 5x0.34 shielded gy UL/CSA 15m

Female 90°

M12, 5-pole

shielded

with cable sleeves

Plastic housings with good resistance against chemicals and oils.

The resistance to aggressive media should be individually tested for your application. Further details on request.

Further cable lengths on request.

Illustration

stay connected

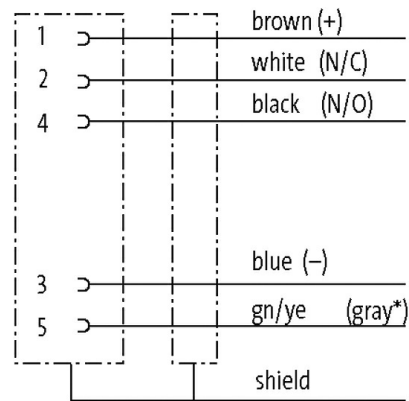
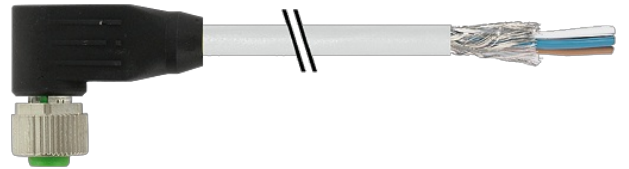

(* for cable type 203, 603, 243, 643)

Female



Product may differ from Image

Approvals



cCSAus

* only for products with UL/CSA approved cable

EAC

Form

Form 13281

Cables

No./diameter of wires	5 × 0.34 mm ²
Wire isolation	PVC (br, wh, bl, bk, gr)
Material (jacket)	PVC (UL/CSA)
Outer Ø	5.6 mm ±5%
Temperature range (fixed)	-30...+80 °C
Temperature range (mobile)	-5...+80 °C
Cable identification	203
Cable Type	1 (PVC)
Approval (cable)	UL (AWM-Style 2464/1731), CSA
Cable weight [g/m]	68,20
Material (wire)	Cu wire, bare
Resistor (core)	max. 57 Ω/km (20 °C)
Single wire Ø (core)	0.15 mm
Construction (core)	19 × 0.15 mm (multi-strand wire class 5)
Diameter (core)	5 × 0.34 mm ²
AWG	similar to AWG 22
Material (wire isolation)	PVC
Material property (wire isolation)	CFC-, cadmium-, silicone- and lead-free
Shore hardness (wire isolation)	45 ±5 D
Wire-Ø incl. isolation	1.25 mm ±5%
Color/numbering of wires	br, bk, bl, wh, gr
Stranding combination	5 wires twisted around central filler
Shield	yes
Material (jacket)	PVC
Material property (jacket)	CFC-, cadmium-, silicone- and lead-free
Shore hardness (jacket)	85 ±5 A
Outer-Ø (jacket)	5.6 mm ±5%
Color (jacket)	gray
chemical resistance	good resistance to oil, gasoline and chemicals
thermal resistance	flame retardant UL 1581 VW1 / CSA FT1
Nominal voltage	300 V AC
Test voltage	2000 V AC
Current load capacity	to DIN VDE 0298-4
Temperature range (fixed)	-30...+80 °C
Temperature range (mobile)	-5...+80 °C
Bend radius (fixed)	10 × outer Ø
Jacket Color	gray

Technical Data

Operating voltage	max. 60 V AC/DC
Operating voltage (only UL listed)	30 V AC/DC
Rated surge voltage	1.5 kV
Operating current per contact	max. 4 A
No. of poles	5

Material group	IEC 60664-1, category I
Coding	A-coded
LED display	no
Locking of ports	Screw thread (M12×1 mm) recommended torque 0.6 Nm, self-securing
Compression gland	M12 (SW13)
Protection	IP65, IP66K, IP67 inserted and tightened (EN 60529)
Locking material	Zinc die casting, matte nickel plated
Material	PUR
suitable for corrugated tube (internal Ø)	without

General data

Standards	DIN EN 61076-2-101 (M12)
Mounting method	inserted, tightened
Material (contact)	Copper alloy
Material (contact surface)	Au
Material (gasket)	FKM
Pollution Degree	3
Stripping length (jacket)	20 mm
Temperature range	-25...+85 °C, depending on cable quality

Commercial data

country of origin	CZ
customs tariff number	85444290
EAN	4048879624992
eClass	27279218
Packaging unit	1